

Receiver Protector Selection Guide

CPI Electron Device Business' Receiver Protectors

Solid state limiters, TR limiters,
Pre-TR limiters, Pre-TR tubes, TR tubes, ATR tubes, multipactors

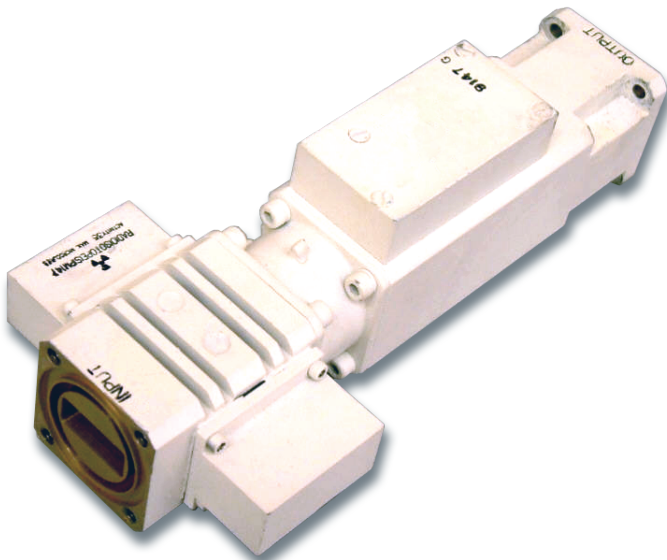
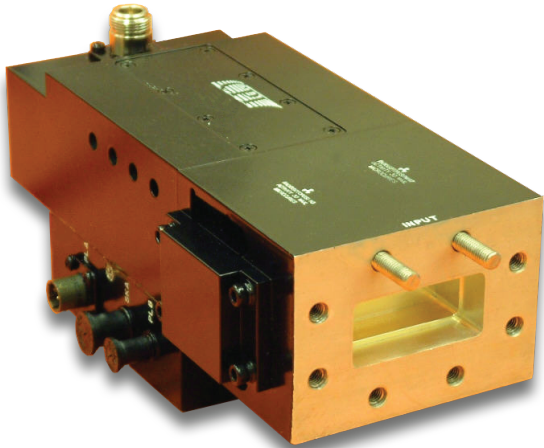

FEATURES:

- Passive operation protects even if system is turned off
- High power, high duty cycle operation
- Small contribution to system noise figure
- Low leakage protects even the most sensitive receivers
- Very fast recovery time ensures stable target detection at minimum range
- Integral multi-function capability available for improved performance at reduced cost
- Long operating and storage life available

BENEFITS:

- World's largest manufacturer of receiver protectors
- State of the art facility with high level of vertical integration
- Extensive high power test capability
- In-house environmental test facility
- Computer modeling and automatic test capabilities

APPLICATIONS:

- Ground based radars
- Airborne radars
- Missile seekers
- Naval radars
- Unmanned aerial vehicles (UAV)
- Weather radars
- Air traffic control radars
- Navigation radars
- Fire control radars

Please note: The data below indicate typically achievable limits for receiver protectors in each frequency band. The actual combination of performance characteristics which may be realized for any specific device will depend on the design trade-offs required for its particular system application.

Specifications

Frequency band	VHF/UHF	L	S	C	X	Ku	K	Ka
Bandwidth (%)	>15	>15	>12	>12	>12	>12	>10	>8
Peak power handling (kW)	1000	1000	1000	1000	250	250	100	100
Average power handling (kW)	50	50	45	20	10	5	2	1
Duty cycle	>10	>10%	>10%	>10%	>10%	>10%	>10%	>10%
Pulsewidth (μsec)	>200	>200	>200	>200	>200	>200	>200	>200
VSWR	1:3:1	1:3:1	1:4:1	1:4:1	1:4:1	1:4:1	1:5:1	1:5:1
Insertion loss (dB)	<0.5	<0.5	<0.6	<0.8	<1.0	<1.5	<1.8	<2.0
Flat leakage power (mW)	20	<20	<20	<20	<20	<20	<20	<20
Spike leakage power (mW)	100	<100	<100	<100	<100	<100	<100	<100
3dB Recovery time (μsec)	<1.0	<1.0	<1.0	<0.5	<0.1	<0.1	<0.1	<0.13 dB

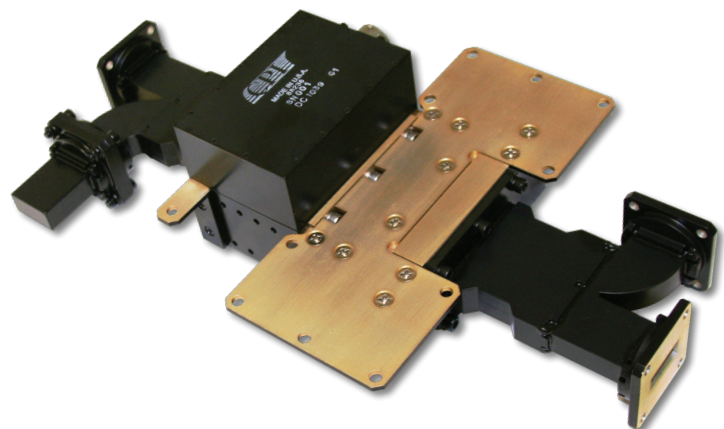

One or more additional functions can be integrated into almost any receiver protector, thus eliminating the need for extra system components. Doing this can result in better performance in a smaller package at lower overall cost. The features and benefits of typical functions which may be added to a receiver protector are on the next page.

EXCESS ATTENUATION:

- Blanking, variable step, or continuously variable
- Maximum attenuation levels up to 60 dB or more
- Linearized or non-linearized
- With or without integral driver
- Analog or digital control

BENEFITS:

- Attenuation function can be realized with minimal or possibly no additional insertion loss
- Lower overall cost
- Integration allows for more compact overall form factor



BITE/FAULT MONITORING:

- Monitor limiter diode status
- Monitor stress on limiter diodes
- Monitor level of output leakage

BENEFITS:

- Provides warning of impending failure of receiver protector
- Can be used to prevent failure of receiver protector and/or succeeding components
- Reduce overall system maintenance costs

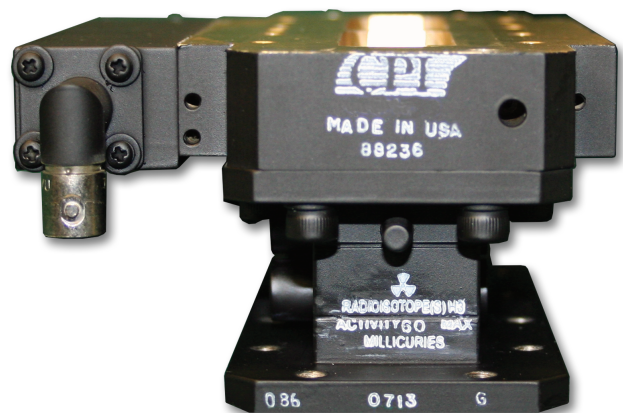

CPI EDB's Receiver Protectors: Multi-function Capabilities,

LOW NOISE AMPLIFIERS:

- Noise Figure as low as 2.0

BENEFITS:

- Lower overall Noise Figure
- Lower overall cost
- Integration allows for more compact overall form factor



EXCESS NOISE GENERATION:

- Up to 15 dB excess noise
- Single level within +/- 1.5 dB tolerance
- Voltage control 12 V typical

BENEFITS:

- Can be incorporated with little to no additional insertion loss
- Useful for system calibration
- Lower overall cost
- Integration allows for more compact overall form factor

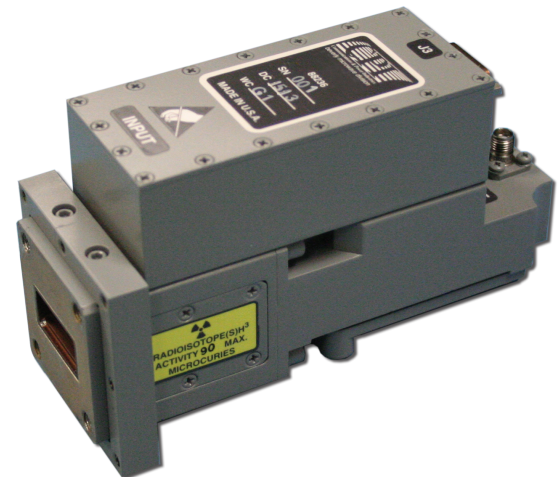

INTEGRATED PASSIVE FUNCTIONS:

- Filters
- Couplers
- Non-reflective limiting/ attenuation
- Extended operating life

BENEFITS:

- Lower overall cost
- Integration allows for more compact overall form factor
- Improved system performance

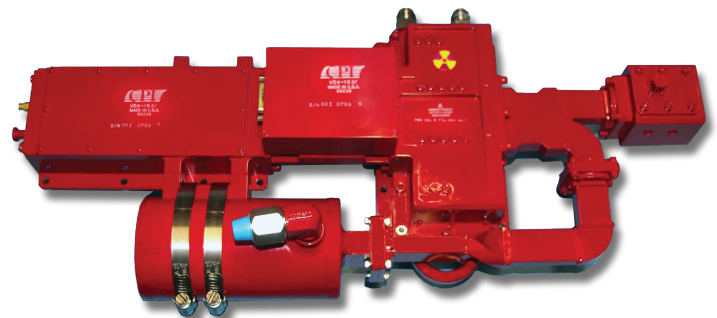

Duplexers

Receiver protectors are normally used in a radar system as part of the duplexing function. In some configurations, the receiver protector actually performs the duplexing function in addition to its protection activities. CPI EDB has the capability to design and produce complete duplexers. This can offer the user improved performance at reduced size and lower overall costs. Typical duplexer configurations are discussed below.

Circulator Duplexers

This is the most common type of duplexer found in modern radar systems. A 3 – or 4- port ferrite circulator performs the actual duplexing function. However, the isolation of the circulator is normally not high enough to adequately protect the receiver from the transmitter. So, a receiver protector is located in the receive channel to perform that function.

FEATURES:

- Relatively broadband
- More compact configuration
- Moderate to high power handling

BENEFITS:

- Often can provide the best balance of cost, physical size, and operating characteristics
- Circulator has no operating life limit

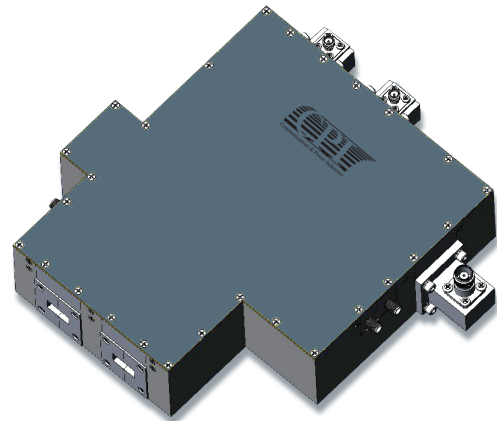

Balanced Hybrid Duplexers

In this duplexer type, a “switching element” is placed between two 90O hybrids. When the switching element is “off,” power is directed from the antenna port to the receiver port. When the switching element is “on,” power is directed from the transmitter port to the antenna port. The topology of a balanced hybrid duplexer is very flexible. The switching element can be anything from a dual SPST switch to a complete receiver protector. Depending upon the type of switching element used, a separate receiver protector may or may not be needed in the receive channel.

FEATURES:

- Relatively broadband
- Very high power handling
- Can be designed with field replaceable parts

BENEFITS:

- Design flexibility
- Integral receiver protection



CPI EDB Duplexers, cont'd

Branched Duplexers

The branched duplexer is made by mounting a "switching element" to a Tee junction. When the switching element is "off," power is directed from the antenna port to the receiver port. When the switching element is "on," power is directed from the transmitter port to the antenna port. The switching element is usually a complete receiver protector.

FEATURES:

- Relatively narrow band
- High power handling
- Compact topology

BENEFITS:

- Low cost
- Integral receiver protection

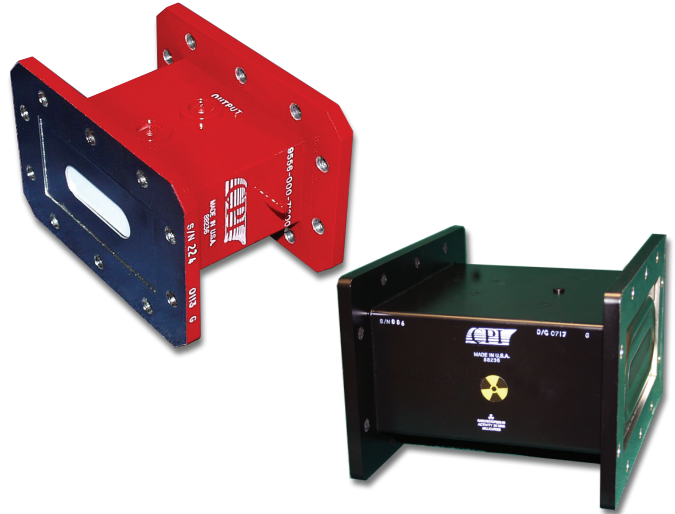

This Radar Block Diagram depicts the various building blocks of a typical radar system that CPI EDB is capable of integrating to fit your design needs.

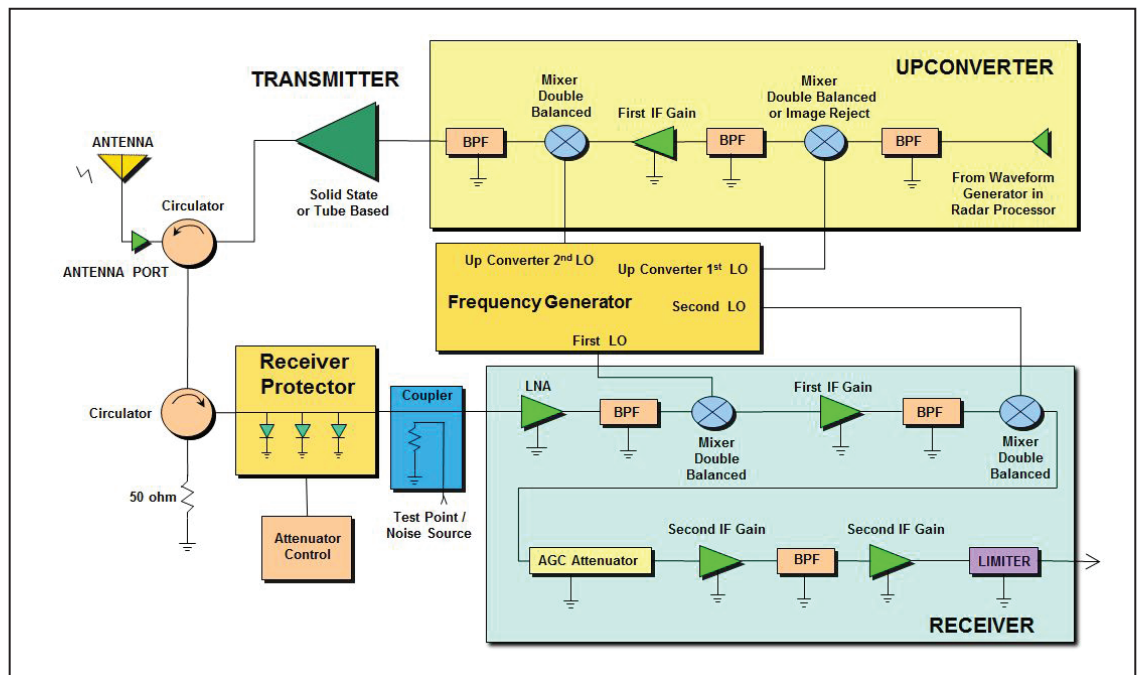

CPI Electron Device Business
 150 Sohier Road
 Beverly, Massachusetts
 01915-5536 USA

tel +1 978-922-6000
 email ElectronDevices@cpi-edb.com
 fax +1 (978) 922-2736
 web www.cpi-edb.com

For more detailed information, please refer to the corresponding CPI EDB technical description if one has been published, or contact CPI EDB. Specifications may change without notice as a result of additional data or product refinement. Please contact CPI EDB before using this information for system design.

©2025 CPI Electron Device Business . Company proprietary: use and reproduction is strictly prohibited without written authorization from CPI EDB.